



ENERGYbase

Monitoring results DEC systems 2010, 2011

Anita Preisler

IEA SHC Task 48 Expertmeeting

Milan – 26.-27. March 2012

Content

- DEC System
- Monitoring hardware
- Monitoring evaluation
 - Primary energy savings
 - Performance of components
- Conclusions

Solar cooling (DEC-system)

- Concept of operation:
 - DEC-system delivers air conditioned fresh air in summer
 - 100% solar thermal driven solar cooling system by 285m² flat plate collectors
 - Usage of DEC-system for humidity and heat recovery in winter

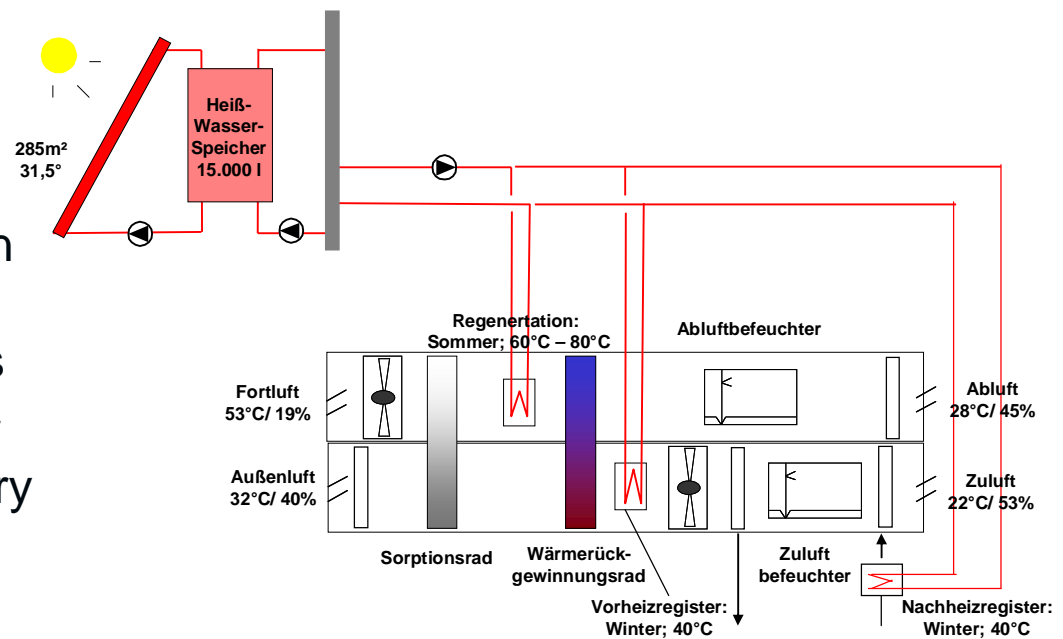

Source: AIT

Monitoring hardware

- DEC-System and solar thermal system: 151 sensors
 - Solar thermal system:
 - global irradiation on solar collector area
 - temperatures (primary loop, secondary loop, storage)
 - energy meters (primary loop, secondary loop, solar cooling)
 - pressure

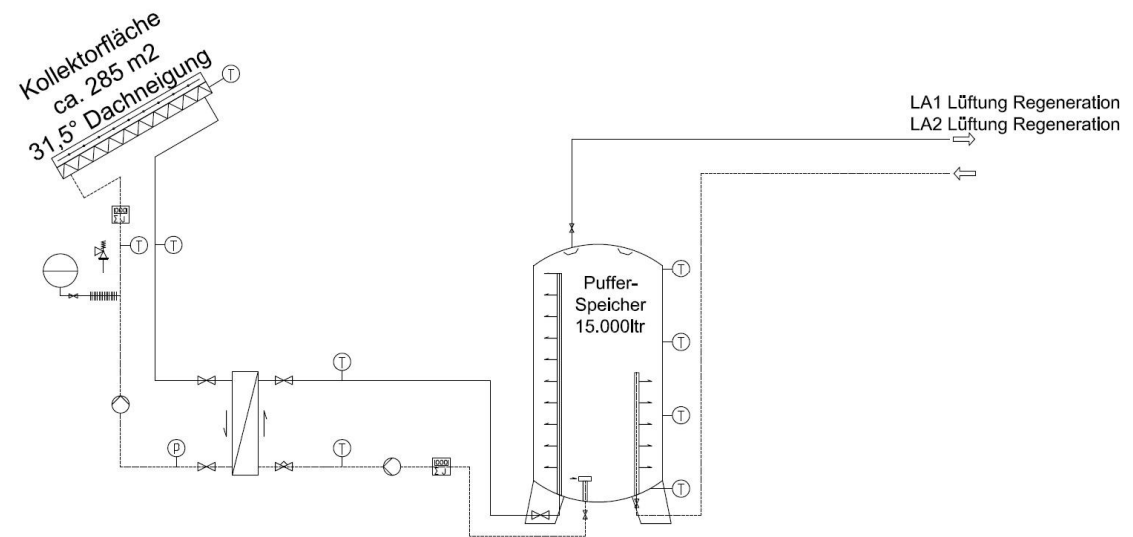

Source: AIT

Monitoring hardware

- DEC-System:
 - temperatures, humidity (outside, after each main component)
 - volume flow (supply air, return air)
 - temperatures (primary loop, secondary loop, storage)
 - energy meters (heating coils)

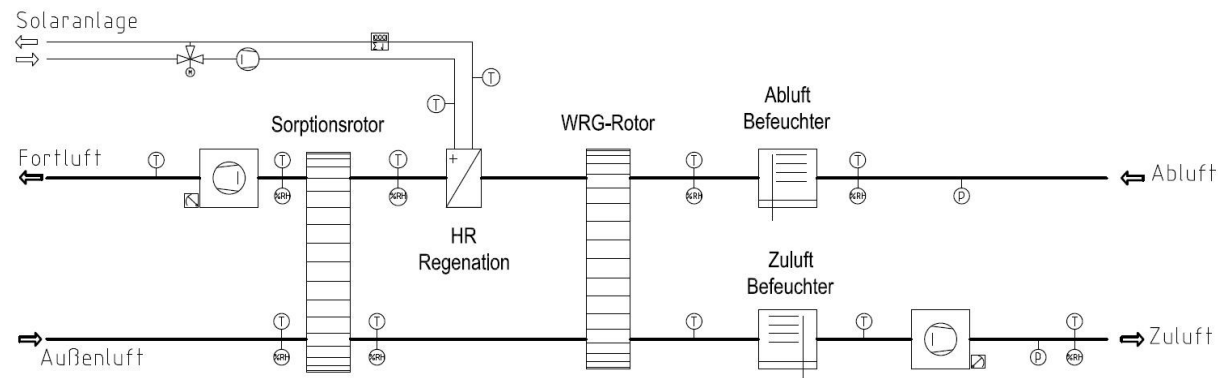

Monitoring evaluation

- Primary energy savings (absolute per year):
 - **Winter** (Jan – March and Oct – Dec):
138.470 kWh → **73,9%**
 - **Summer** (June, July, Aug):
34.133 kWh → **18,2%**
 - **Transition time** (April, May and Sept):
14.774 kWh → **7,9%**

- **Highest primary energy saving potential absolute in winter time for Austrian climate**

Used parameters according to Task 38 monitoring procedure:

- PE conversion electricity: 2,5
- PE conversion gas: 1,11
- SPF compression chillers: 2,8
- Efficiency gas boiler: 0,95
- SPF heat pump (measured): 3,2

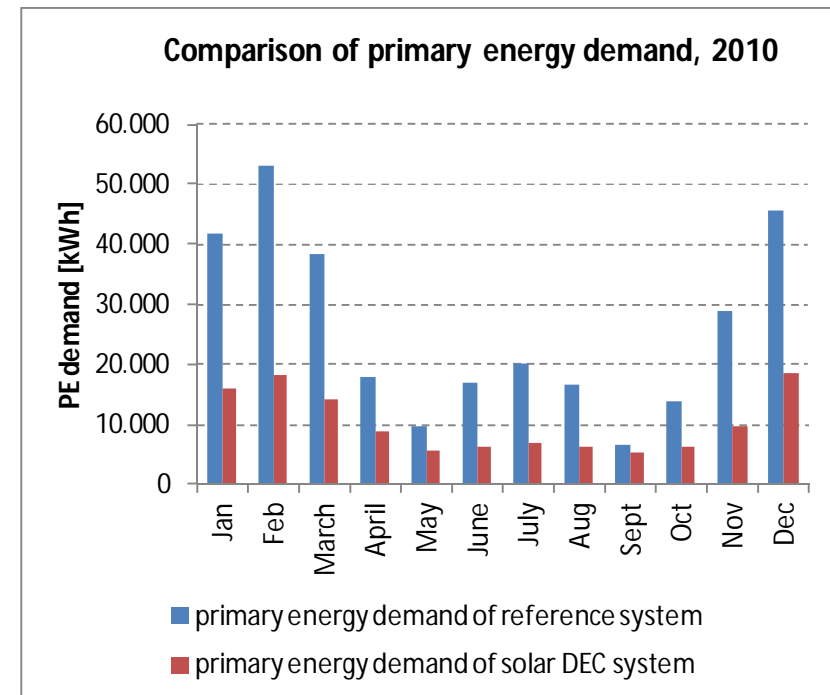

Source: AIT

Monitoring evaluation

- Composition of primary energy demand:
 - Reference system: highest demand for heating coils (supply air 22° C; 42% r.H.)
 - Solar DEC system:
 - heating demand in winter much lower due to enthalpy rotor
 - Electricity demand for solar system in summer very low

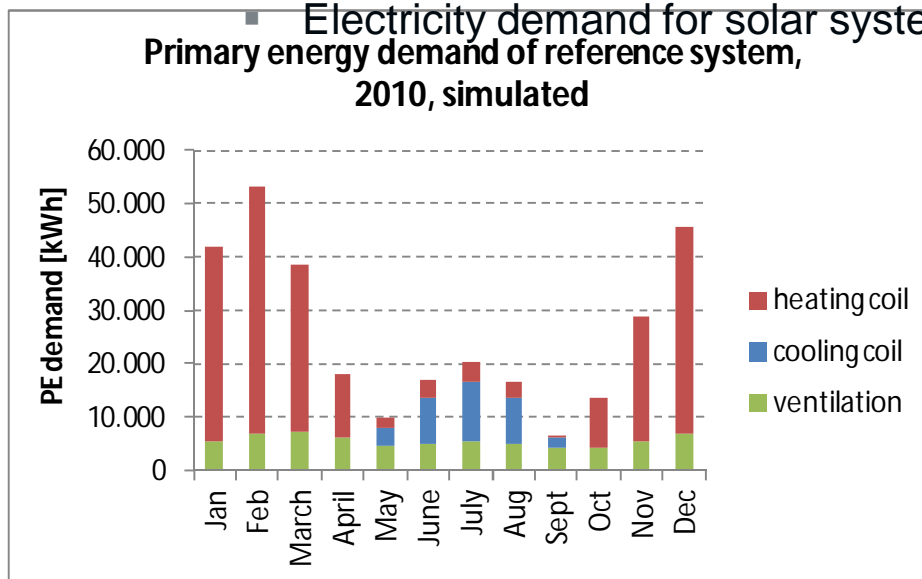

Source: AIT

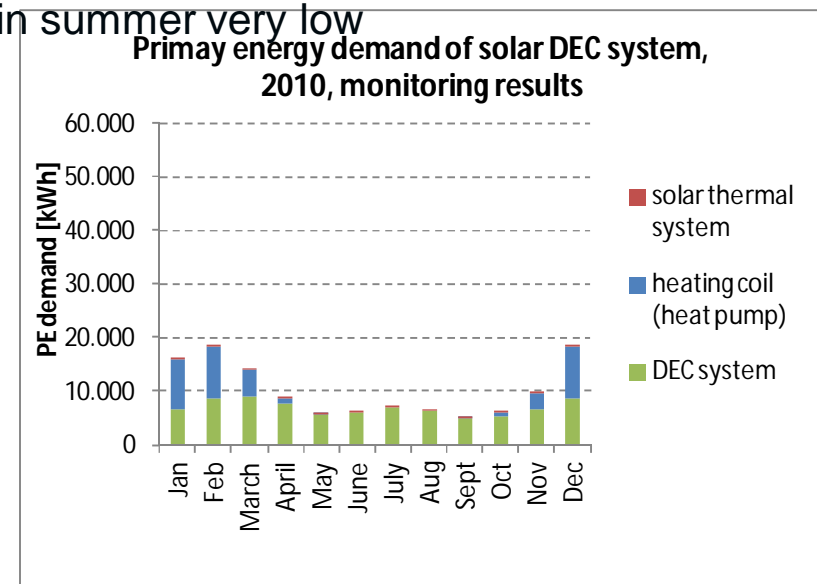

Source: AIT

Monitoring evaluation

- Primary energy savings (relative per month):
 - Quite high primary energy saving potential in summer and winter (~ 60%)
 - Task 38 Level 3 evaluation (right diagram) show monthly differences related to climatic conditions in 2010 and 2011 (July 2010: very hot; July 2011: very rainy and cold)

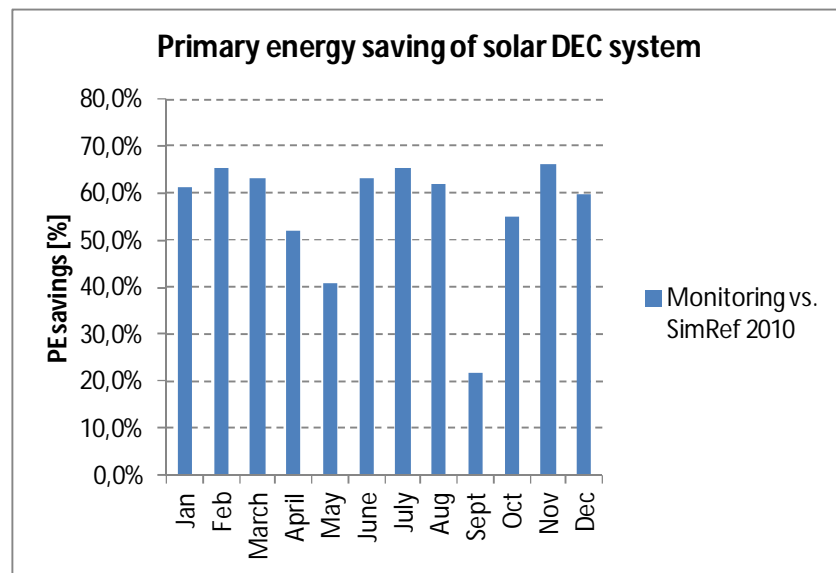

Source: AIT

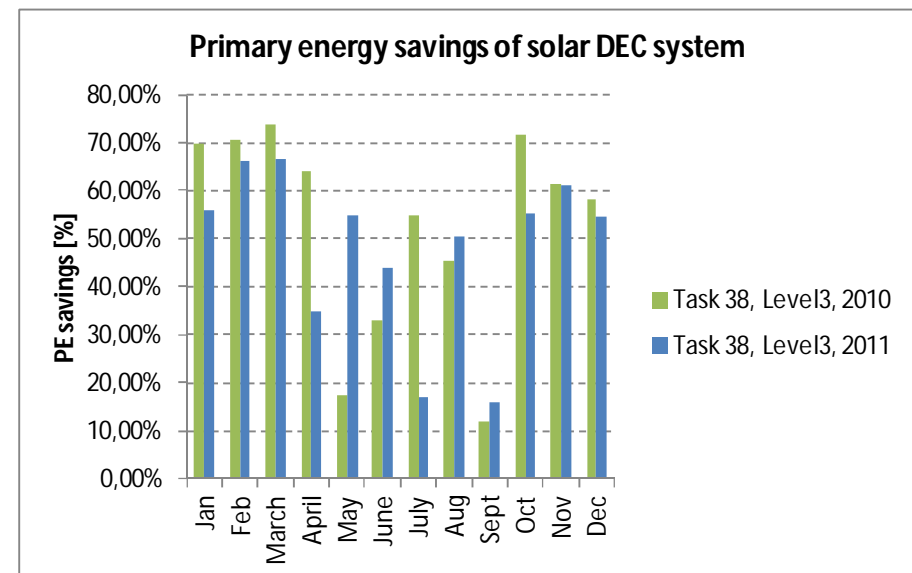

Source: AIT

Monitoring evaluation

- Operation modes of DEC System
 - Sorption rotor always in operation during office time
 - 87,5 % in heat an humidity recovery mode (enthalpy rotor)
 - 12,0% in dehumidification mode
 - Heat recovery rotor (73,3% in operation)
 - 46,6% heating supply air
 - 26,7% cooling supply air
 - Spray humidifier
 - Return air: 19,0%
 - Supply air (summer): 14,0%

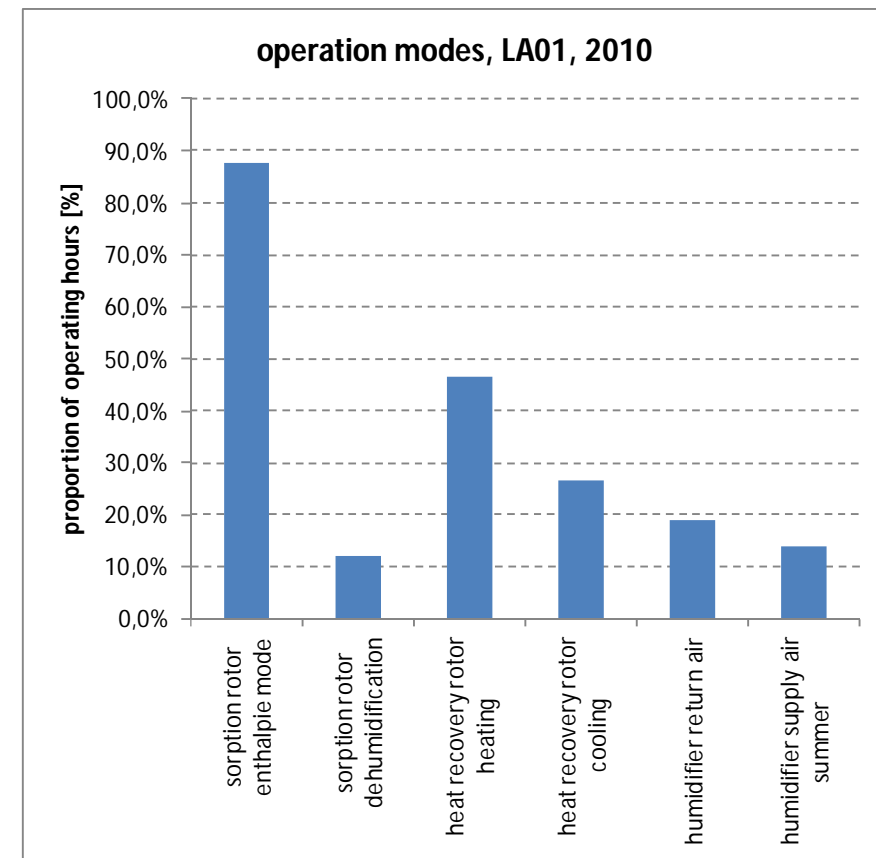

Source: AIT

Monitoring evaluation

- Performance of sorption rotor (LiCl) in 2010
 - Humidity recovery (left diagram): approx. linear between 0 and 6,6 g/kg
 - Dehumidification (right diagram):
 - 62 % of the time nearly constant at 2,8 g/kg
 - 38 % of the time between 3,0 and 4,4 g/kg

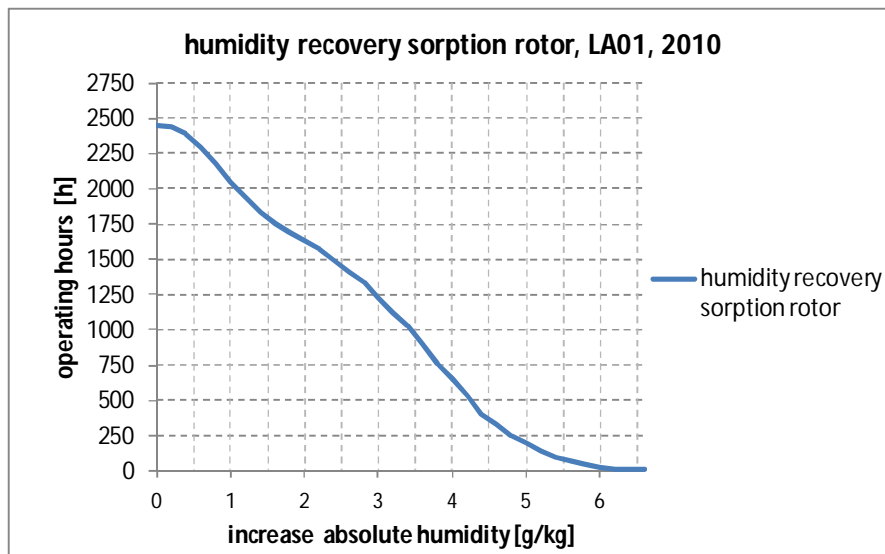

Source: AIT

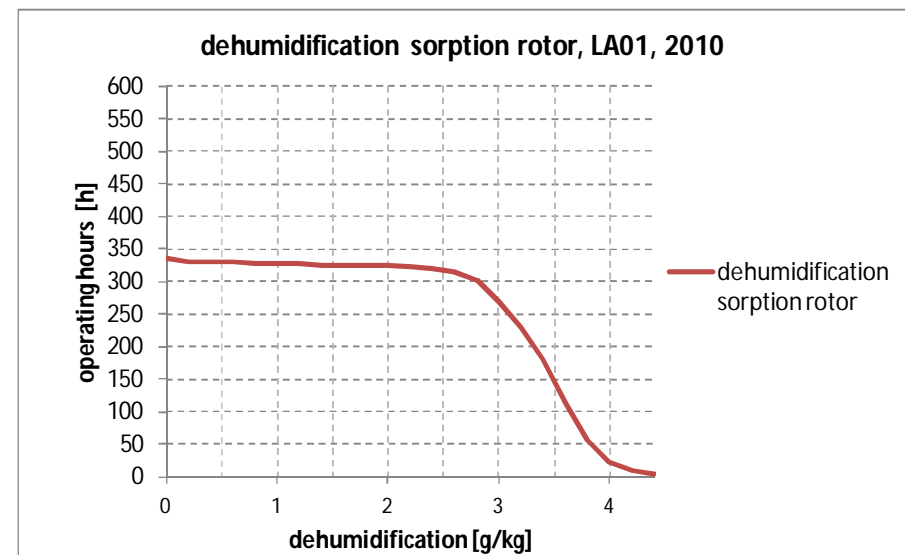

Source: AIT

Monitoring evaluation

- Performance of heat recovery rotor in 2010
 - Heat recovery for heating purposes (left diagram)
 - Heat recovery for cooling purposes (right diagram)

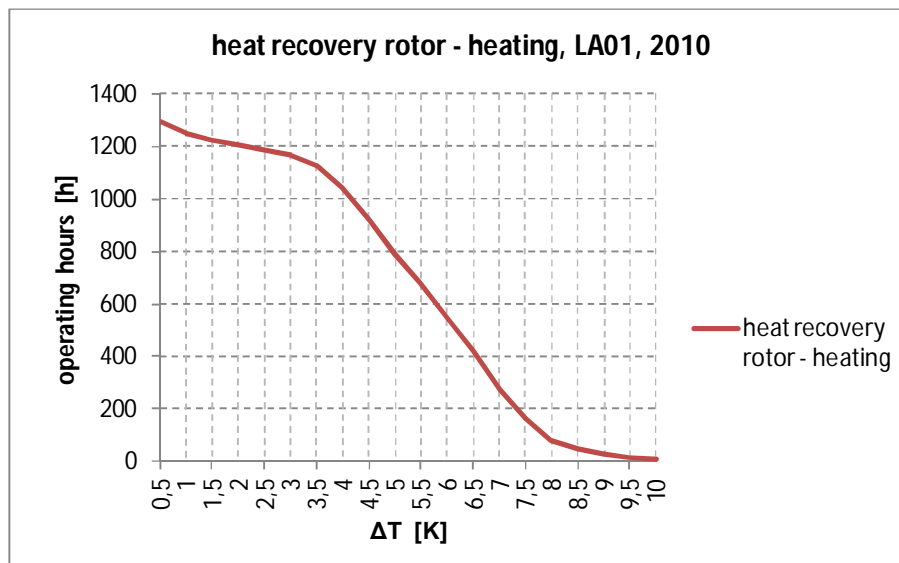

Source: AIT

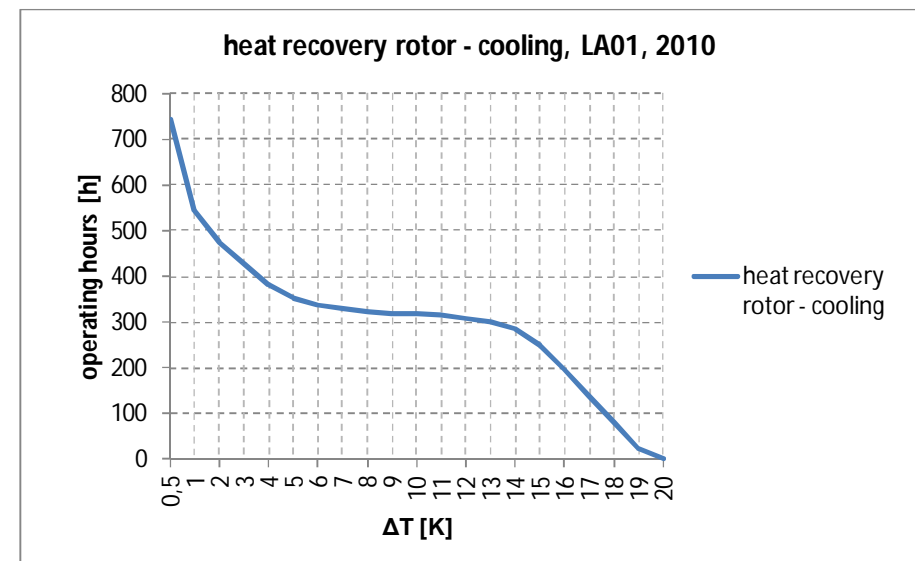

Source: AIT

Monitoring evaluation

- Performance of spray humidifier in 2010
 - Humidifier return air (left diagram)
 - Both humidifier (supply air and return air) during summer (right diagram)

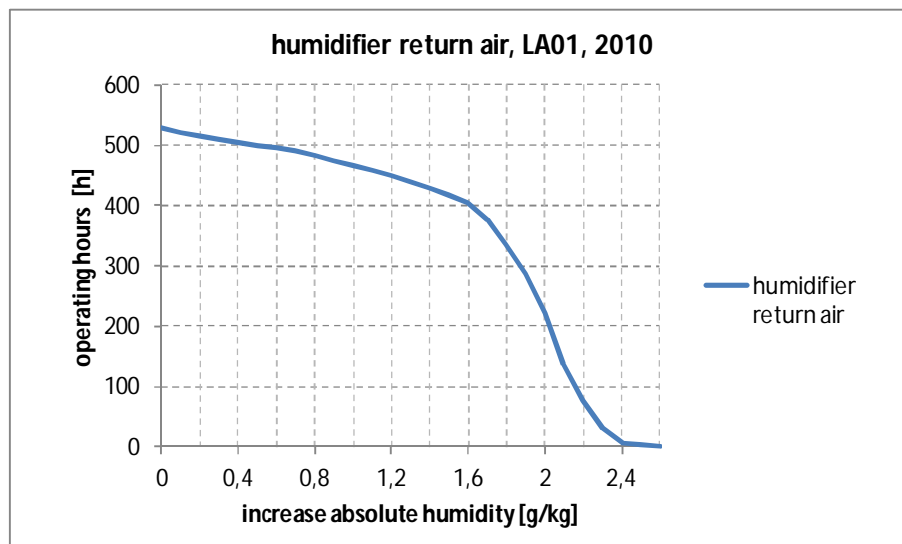

Source: AIT

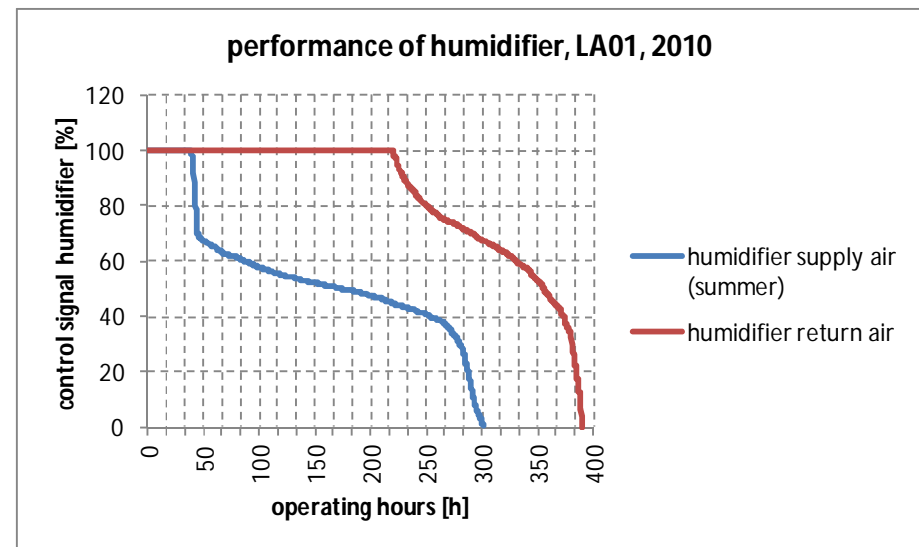

Source: AIT

Conclusions

- Monitoring evaluations show a great primary energy saving potential for solar DEC systems especially in winter time
- Dehumidification performance of sorption rotor is quite low (most of the time not higher than 2,8 g/kg)
- Summer operation is also very energy efficient compared to a reference system with compression chillers (primary energy savings 40 – 60 %)